



BGU8053

Low noise high linearity amplifier

Rev. 2 — 30 December 2013

Product data sheet

1. Product profile

1.1 General description

The BGU8053 is a low noise high linearity amplifier for wireless infrastructure applications, equipped with fast shutdown to support TDD systems. The LNA has a high input and output return loss and is designed to operate between 2 GHz and 4 GHz. It is housed in a 2 mm × 2 mm × 0.75 mm 8-terminal plastic thin small outline package. The LNA is ESD protected on all terminals.

1.2 Features and benefits

- Low noise performance: $NF = 0.56$ dB
- High linearity performance: $IP3O = 36$ dBm
- High input return loss > 12 dB
- High output return loss > 20 dB
- Unconditionally stable up to 20 GHz
- Programmable bias current (via resistor)
- Small 8-terminal leadless package 2 mm × 2 mm × 0.75 mm
- ESD protection on all terminals
- Moisture sensitivity level 1
- Fast shutdown to support TDD systems
- +5 V single supply

1.3 Applications

- Wireless infrastructure
- Low noise and high linearity applications
- LTE, W-CDMA, CDMA, GSM
- General purpose wireless applications
- TDD or FDD systems
- Suitable for small cells



1.4 Quick reference data

Table 1. Quick reference data

$f = 2500$ MHz; $V_{CC} = 5$ V; $T_{amb} = 25$ °C; input and output 50Ω ; $R_{bias} = 5.1$ k Ω ; unless otherwise specified. All RF parameters are measured in an application board as shown in [Figure 15](#) with components listed in [Table 9](#) optimized for $f = 2500$ MHz.

Symbol	Parameter	Conditions	Min	Typ	Max	Unit
I _{CC}	supply current	on state	36	48	60	mA
		off state	-	2.8	-	mA
G _{ass}	associated gain	on state	17	18.5	20	dB
		off state	-	-23.5	-	dB
NF	noise figure		[1]	0.56	0.75	dB
P _{L(1dB)}	output power at 1 dB gain compression		-	18	-	dBm
IP3 _O	output third-order intercept point	2-tone; tone spacing = 1 MHz; P _i = -15 dBm per tone	32	36	-	dBm

[1] Connector and Printed-Circuit Board (PCB) losses have been de-embedded.

2. Pinning information

2.1 Pinning

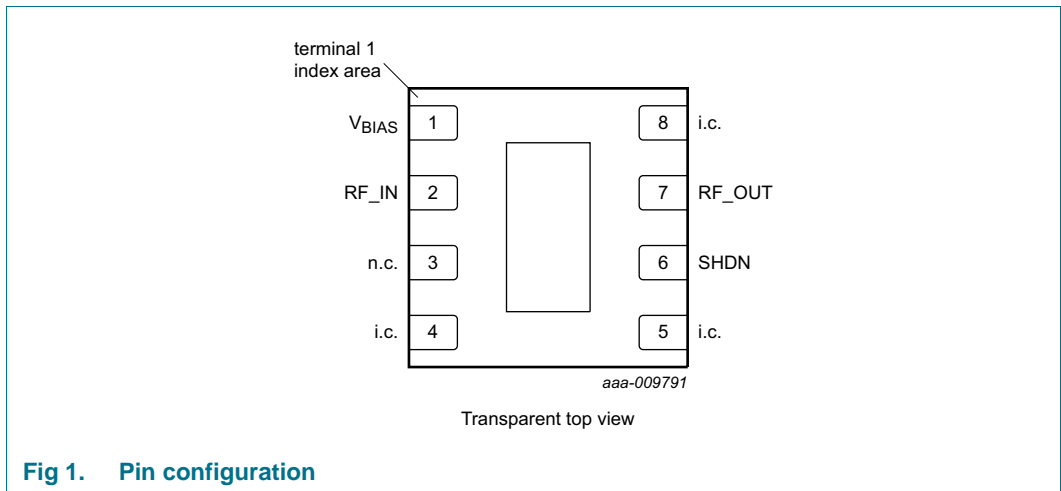

Fig 1. Pin configuration

2.2 Pin description

Table 2. Pin description

Symbol	Pin	Description
V _{BIAS}	1	bias voltage
RF_IN	2	RF input
n.c.	3	not connected
i.c.	4, 5, 8	internally connected. Can be grounded or left open in the application
SHDN	6	shutdown
RF_OUT	7	RF output
GND	exposed die pad	ground

3. Ordering information

Table 3. Ordering information

Type number	Package		Version
	Name	Description	
BGU8053	HWSO8	plastic thermal enhanced very very thin small outline package; no leads; 8 terminals; body 2 × 2 × 0.75 mm	SOT1327-1

4. Limiting values

Table 4. Limiting values

In accordance with the Absolute Maximum Rating System (IEC 60134).

Symbol	Parameter	Conditions	Min	Max	Unit
V_{CC}	supply voltage		-	6	V
$V_{ctrl(sd)}$	shutdown control voltage		-	3	V
I_{CC}	supply current		-	85	mA
$P_{i(RF)CW}$	continuous waveform RF input power		-	20	dBm
T_{stg}	storage temperature		-40	+150	°C
T_j	junction temperature		-	150	°C
P	power dissipation	$T_{case} \leq 125 \text{ °C}$	[1]	510	mW
V_{ESD}	electrostatic discharge voltage	Human Body Model (HBM) According to ANSI/ESDA/JEDEC standard JS-001-2010	-	0.9	kV
		Charged Device Model (CDM); According JEDEC standard 22-C101B	-	2	kV

[1] Case is ground solder pad.

5. Recommended operating conditions

Table 5. Characteristics

Symbol	Parameter	Conditions	Min	Typ	Max	Unit
V_{CC}	supply voltage		4.75	5	5.25	V
Z_0	characteristic impedance		-	50	-	Ω
T_{case}	case temperature		-40	-	+85	°C

6. Thermal characteristics

Table 6. Thermal characteristics

Symbol	Parameter	Conditions	Typ	Unit
$R_{th(j-case)}$	thermal resistance from junction to case		[1][2] 50	K/W

[1] Case is ground solder pad.

[2] Thermal resistance measured using infrared measurement technique, device mounted on application board and placed in still air.

7. Characteristics

Table 7. Characteristics

$f = 2500 \text{ MHz}$; $V_{CC} = 5 \text{ V}$; $T_{amb} = 25 \text{ }^\circ\text{C}$; input and output $50 \text{ } \Omega$; $R_{bias} = 5.1 \text{ k}\Omega$; unless otherwise specified. All RF parameters are measured in an application board as shown in [Figure 15](#) with components listed in [Table 9](#) optimized for $f = 2500 \text{ MHz}$.

Symbol	Parameter	Conditions	Min	Typ	Max	Unit
I_{CC}	supply current	on state	36	48	60	mA
		off state	-	2.8	-	mA
G_{ass}	associated gain	on state	17	18.5	20	dB
		off state	-	-23.5	-	dB
NF	noise figure		[1]	0.56	0.75	dB
$P_{L(1dB)}$	output power at 1 dB gain compression		-	18	-	dBm
$IP3_O$	output third-order intercept point	2-tone; tone spacing = 1 MHz; $P_i = -15 \text{ dBm}$ per tone	32	36	-	dBm
		2-tone; tone spacing = 1 MHz; $P_i = -15 \text{ dBm}$ per tone	[2]	30	34	-
RL_{in}	input return loss	on state	-	12.2	-	dB
		off state	-	6.3	-	dB
RL_{out}	output return loss		-	28.0	-	dB
ISL	isolation		-	22.0	-	dB
$t_{s(pon)}$	power-on settling time	$P_i = -20 \text{ dBm}$; SHDN (pin 6) from HIGH to LOW	[2]	1.4	-	μs
$t_{s(poff)}$	power-off settling time	$P_i = -20 \text{ dBm}$; SHDN (pin 6) from LOW to HIGH	[2]	0.4	-	μs
K	Rollett stability factor	both on state and off state up to $f = 20 \text{ GHz}$	1	-	-	
$R_{pd(SHDN)}$	pull-down resistance on pin SHDN		-	30	-	$\text{k}\Omega$

[1] Connector and Printed-Circuit Board (PCB) losses have been de-embedded.

[2] For TDD systems where fast switching is required, it is recommended to change C1 and C2 to 100 pF.

Table 8. Shutdown control

$V_{CC} = 5 \text{ V}$; $T_{amb} = 25 \text{ }^\circ\text{C}$; input and output $50 \text{ } \Omega$; $R_{bias} = 5.1 \text{ k}\Omega$; unless otherwise specified. All RF parameters are measured in an application board as shown in [Figure 15](#) with components listed in [Table 9](#) optimized for $f = 2500 \text{ MHz}$.

State	$V_{ctrl(sd)}$ [1] (V)
on state	≤ 0.6
off state	≥ 1.2

[1] Voltage on pin 6 (SHDN).

7.1 Graphs

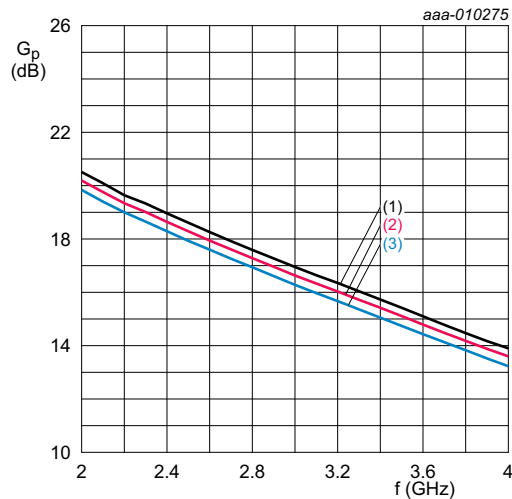

$V_{CC} = 5\text{ V}; I_{CC} = 48\text{ mA}$.

- (1) $T_{amb} = -40\text{ }^{\circ}\text{C}$
- (2) $T_{amb} = +25\text{ }^{\circ}\text{C}$
- (3) $T_{amb} = +85\text{ }^{\circ}\text{C}$

Fig 2. Power gain as a function of frequency; typical values

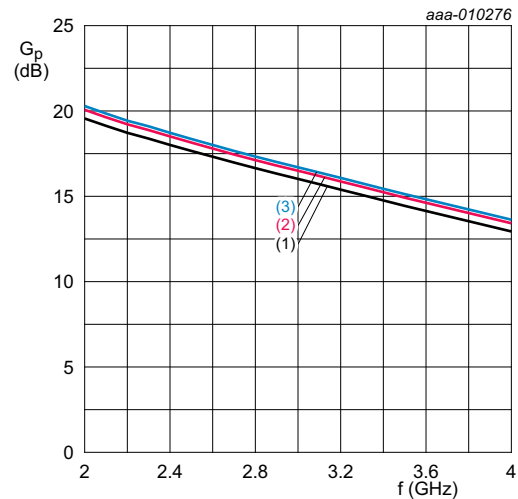

$V_{CC} = 5\text{ V}; T_{amb} = 25\text{ }^{\circ}\text{C}$.

- (1) $I_{CC} = 30\text{ mA}$
- (2) $I_{CC} = 45\text{ mA}$
- (3) $I_{CC} = 60\text{ mA}$

Fig 3. Power gain as a function of frequency; typical values

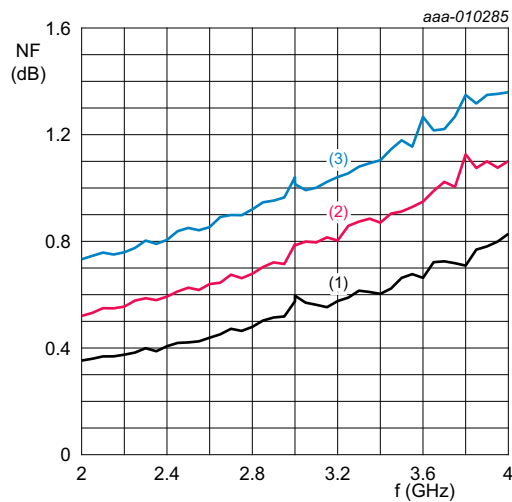

$V_{CC} = 5\text{ V}; I_{CC} = 48\text{ mA}$.

- (1) $T_{amb} = -40\text{ }^{\circ}\text{C}$
- (2) $T_{amb} = +25\text{ }^{\circ}\text{C}$
- (3) $T_{amb} = +85\text{ }^{\circ}\text{C}$

Fig 4. Noise figure as a function of frequency; typical values

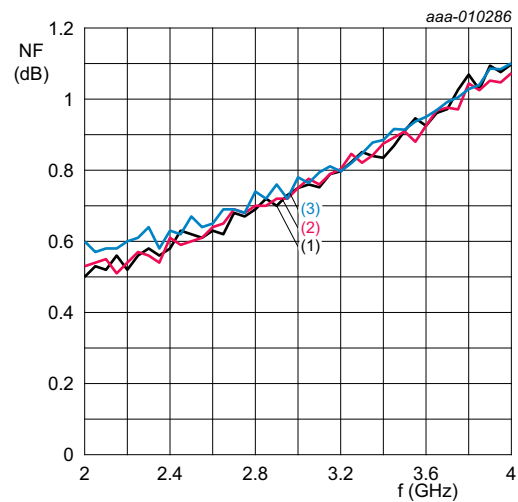

$V_{CC} = 5\text{ V}; T_{amb} = 25\text{ }^{\circ}\text{C}$.

- (1) $I_{CC} = 30\text{ mA}$
- (2) $I_{CC} = 45\text{ mA}$
- (3) $I_{CC} = 60\text{ mA}$

Fig 5. Noise figure as a function of frequency; typical values

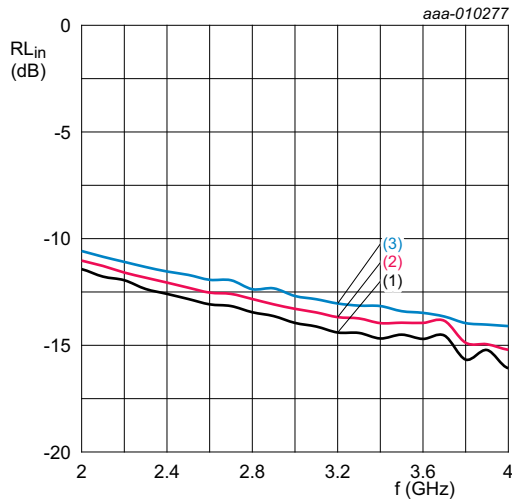

$V_{CC} = 5\text{ V}; I_{CC} = 48\text{ mA}.$
 (1) $T_{amb} = -40\text{ }^{\circ}\text{C}$
 (2) $T_{amb} = +25\text{ }^{\circ}\text{C}$
 (3) $T_{amb} = +85\text{ }^{\circ}\text{C}$

Fig 6. Input return loss as a function of frequency; typical values

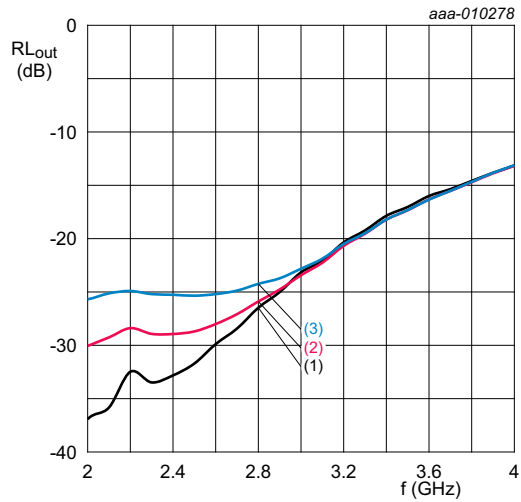

$V_{CC} = 5\text{ V}; I_{CC} = 48\text{ mA}.$
 (1) $T_{amb} = -40\text{ }^{\circ}\text{C}$
 (2) $T_{amb} = +25\text{ }^{\circ}\text{C}$
 (3) $T_{amb} = +85\text{ }^{\circ}\text{C}$

Fig 7. Output return loss as a function of frequency; typical values

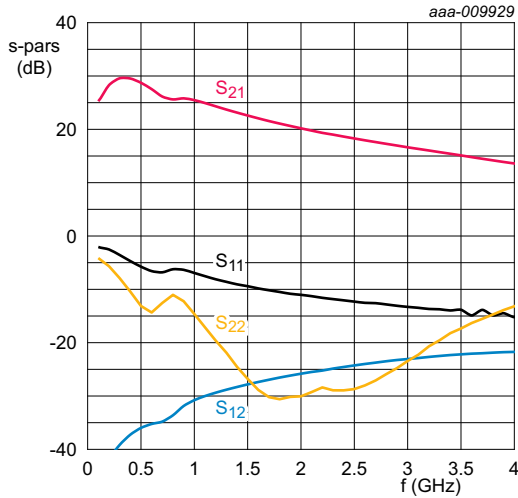

$V_{CC} = 5\text{ V}; T_{amb} = 25\text{ }^{\circ}\text{C}; I_{CC} = 48\text{ mA}.$

Fig 8. Wideband S-parameters as function of frequency; typical values

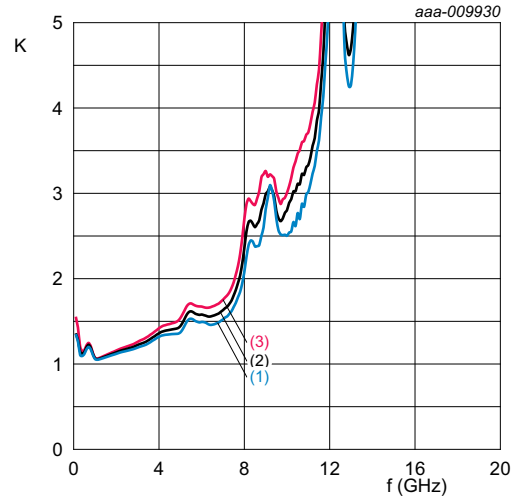

$V_{CC} = 5\text{ V}; I_{CC} = 48\text{ mA}.$
 (1) $T_{amb} = -40\text{ }^{\circ}\text{C}$
 (2) $T_{amb} = +25\text{ }^{\circ}\text{C}$
 (3) $T_{amb} = +85\text{ }^{\circ}\text{C}$

Fig 9. Rollet stability factor as a function of frequency; typical values

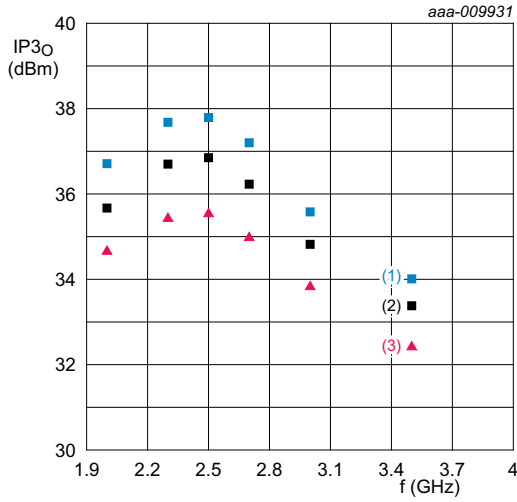

$V_{CC} = 5\text{ V}$; $P_i = -15\text{ dBm}$ per tone; $I_{CC} = 48\text{ mA}$.
 (1) $T_{amb} = -40\text{ }^\circ\text{C}$
 (2) $T_{amb} = +25\text{ }^\circ\text{C}$
 (3) $T_{amb} = +85\text{ }^\circ\text{C}$

Fig 10. Output third-order intercept point as a function of frequency; typical values

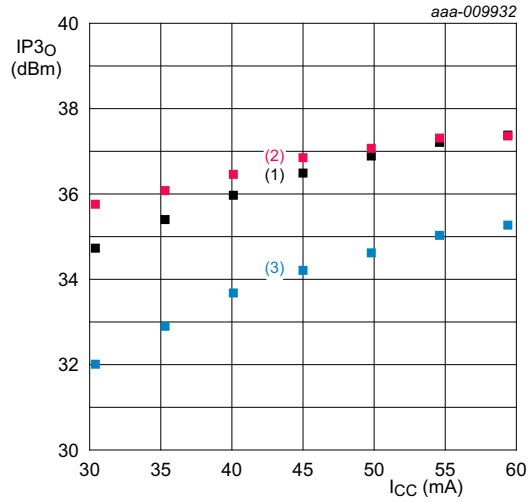

$V_{CC} = 5\text{ V}$; $P_i = -15\text{ dBm}$ per tone; $T_{amb} = 25\text{ }^\circ\text{C}$.
 (1) $f = 2000\text{ MHz}$
 (2) $f = 2500\text{ MHz}$
 (3) $f = 3000\text{ MHz}$

Fig 11. Output third-order intercept point as a function of supply current; typical values

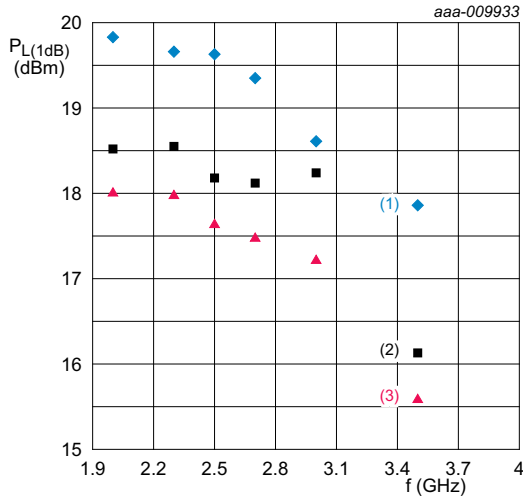

$V_{CC} = 5\text{ V}$; $I_{CC} = 48\text{ mA}$.
 (1) $T_{amb} = -40\text{ }^\circ\text{C}$
 (2) $T_{amb} = +25\text{ }^\circ\text{C}$
 (3) $T_{amb} = +85\text{ }^\circ\text{C}$

Fig 12. Output power at 1 dB gain compression as a function of frequency; typical values

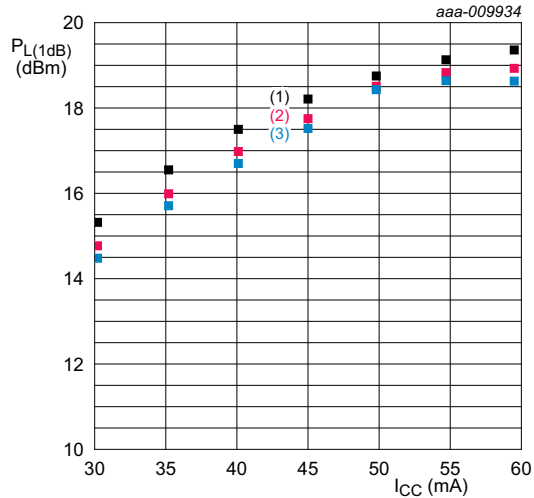

$V_{CC} = 5\text{ V}$; $T_{amb} = 25\text{ }^\circ\text{C}$.
 (1) $f = 2000\text{ MHz}$
 (2) $f = 2500\text{ MHz}$
 (3) $f = 3000\text{ MHz}$

Fig 13. Output power at 1 dB gain compression as a function of supply current; typical values

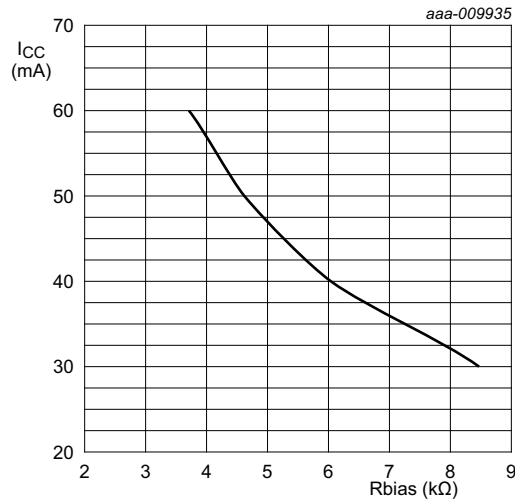

V_{CC} = 5 V.

Fig 14. Supply current as a function of R_{bias}; typical values

8. Application information

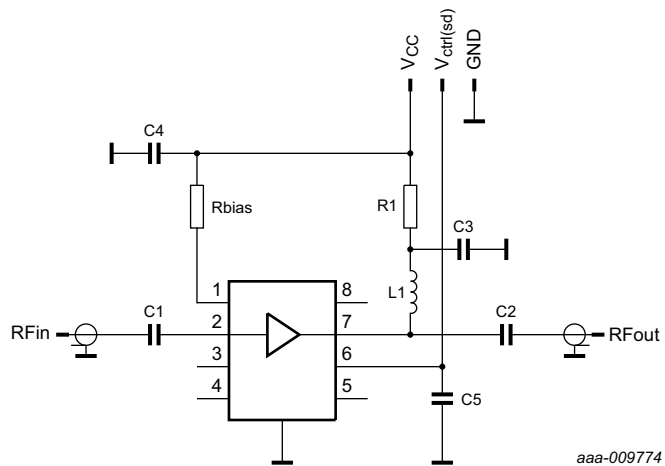

See [Table 9](#) for a list of components.

Fig 15. Schematic of application board

Table 9. List of components

See [Figure 15](#) for schematics.

Component	Description	Value	Remarks
C1, C2	capacitor	100 nF	
		100 pF	recommended for TDD systems
C3, C5	capacitor	10 pF	
C4	capacitor	10 nF	

Table 9. List of components ...continued
See [Figure 15](#) for schematics.

Component	Description	Value	Remarks
L1	inductor	15 nH	
R1	resistor	10 Ω	
Rbias	resistor	5.1 kΩ	

Table 10. Typical performance BGU8053 application board

All RF parameters are measured at the application board as shown in [Figure 15](#) with the components as listed in [Table 9](#) while optimized for: $f = 2500$ MHz; $V_{CC} = 5$ V; $I_{CC} = 48$ mA and $T_{amb} = 25$ °C.

Symbol	Parameter	f (MHz)								
		2000	2300	2500	2700	3000	3400	3500	3800	
G _{ass}	associated gain	20.2	19.0	18.3	17.6	16.6	15.4	15.1	14.2	
RL _{in}	input return loss	11.0	11.8	12.3	12.6	13.3	14.0	13.8	14.9	
RL _{out}	output return loss	30.1	28.9	28.7	27.1	23.4	18.2	17.3	14.7	
P _{L(1dB)}	output power at 1 dB gain compression	18.5	18.6	18.2	18.1	18.2	16.4	16.1	14.4	
IP3 _O	output third-order intercept point	[1]	35.7	36.7	36.8	36.2	34.8	36.2	33.4	33.0
		[1][2]	34.9	35.9	34.5	36.0	32.1	35.3	31.7	31.6
NF	noise figure	[3]	0.52	0.59	0.63	0.68	0.79	0.81	0.83	0.96

[1] 2-Tone; tone spacing = 1 MHz; P₁ = -15 dBm per tone.

[2] For TDD systems C1 and C2 have to be 100 pF.

[3] Connector and board losses not de-embedded.

10. Abbreviations

Table 11. Abbreviations

Acronym	Description
CDMA	Code Division Multiple Access
ESD	ElectroStatic Discharge
FDD	Frequency-Division Duplexing
GSM	Global System for Mobile Communication
LNA	Low Noise Amplifier
LTE	Long Term Evolution
RF	Radio Frequency
TDD	Time-Division Duplexing
W-CDMA	Wideband Code Division Multiple Access

11. Revision history

Table 12. Revision history

Document ID	Release date	Data sheet status	Change notice	Supersedes
BGU8053 v.2	20131230	Product data sheet	-	BGU8053 v.1
Modifications:	<ul style="list-style-type: none"> Table 4 on page 3: The maximum value for $V_{ctrl(sd)}$ has been corrected to 3 V. 			
BGU8053 v.1	20131127	Product data sheet	-	-

12. Legal information

12.1 Data sheet status

Document status ^{[1][2]}	Product status ^[3]	Definition
Objective [short] data sheet	Development	This document contains data from the objective specification for product development.
Preliminary [short] data sheet	Qualification	This document contains data from the preliminary specification.
Product [short] data sheet	Production	This document contains the product specification.

[1] Please consult the most recently issued document before initiating or completing a design.

[2] The term 'short data sheet' is explained in section "Definitions".

[3] The product status of device(s) described in this document may have changed since this document was published and may differ in case of multiple devices. The latest product status information is available on the Internet at URL <http://www.nxp.com>.

12.2 Definitions

Draft — The document is a draft version only. The content is still under internal review and subject to formal approval, which may result in modifications or additions. NXP Semiconductors does not give any representations or warranties as to the accuracy or completeness of information included herein and shall have no liability for the consequences of use of such information.

Short data sheet — A short data sheet is an extract from a full data sheet with the same product type number(s) and title. A short data sheet is intended for quick reference only and should not be relied upon to contain detailed and full information. For detailed and full information see the relevant full data sheet, which is available on request via the local NXP Semiconductors sales office. In case of any inconsistency or conflict with the short data sheet, the full data sheet shall prevail.

Product specification — The information and data provided in a Product data sheet shall define the specification of the product as agreed between NXP Semiconductors and its customer, unless NXP Semiconductors and customer have explicitly agreed otherwise in writing. In no event however, shall an agreement be valid in which the NXP Semiconductors product is deemed to offer functions and qualities beyond those described in the Product data sheet.

12.3 Disclaimers

Limited warranty and liability — Information in this document is believed to be accurate and reliable. However, NXP Semiconductors does not give any representations or warranties, expressed or implied, as to the accuracy or completeness of such information and shall have no liability for the consequences of use of such information. NXP Semiconductors takes no responsibility for the content in this document if provided by an information source outside of NXP Semiconductors.

In no event shall NXP Semiconductors be liable for any indirect, incidental, punitive, special or consequential damages (including - without limitation - lost profits, lost savings, business interruption, costs related to the removal or replacement of any products or rework charges) whether or not such damages are based on tort (including negligence), warranty, breach of contract or any other legal theory.

Notwithstanding any damages that customer might incur for any reason whatsoever, NXP Semiconductors' aggregate and cumulative liability towards customer for the products described herein shall be limited in accordance with the *Terms and conditions of commercial sale* of NXP Semiconductors.

Right to make changes — NXP Semiconductors reserves the right to make changes to information published in this document, including without limitation specifications and product descriptions, at any time and without notice. This document supersedes and replaces all information supplied prior to the publication hereof.

Suitability for use — NXP Semiconductors products are not designed, authorized or warranted to be suitable for use in life support, life-critical or safety-critical systems or equipment, nor in applications where failure or malfunction of an NXP Semiconductors product can reasonably be expected to result in personal injury, death or severe property or environmental damage. NXP Semiconductors and its suppliers accept no liability for inclusion and/or use of NXP Semiconductors products in such equipment or applications and therefore such inclusion and/or use is at the customer's own risk.

Applications — Applications that are described herein for any of these products are for illustrative purposes only. NXP Semiconductors makes no representation or warranty that such applications will be suitable for the specified use without further testing or modification.

Customers are responsible for the design and operation of their applications and products using NXP Semiconductors products, and NXP Semiconductors accepts no liability for any assistance with applications or customer product design. It is customer's sole responsibility to determine whether the NXP Semiconductors product is suitable and fit for the customer's applications and products planned, as well as for the planned application and use of customer's third party customer(s). Customers should provide appropriate design and operating safeguards to minimize the risks associated with their applications and products.

NXP Semiconductors does not accept any liability related to any default, damage, costs or problem which is based on any weakness or default in the customer's applications or products, or the application or use by customer's third party customer(s). Customer is responsible for doing all necessary testing for the customer's applications and products using NXP Semiconductors products in order to avoid a default of the applications and the products or of the application or use by customer's third party customer(s). NXP does not accept any liability in this respect.

Limiting values — Stress above one or more limiting values (as defined in the Absolute Maximum Ratings System of IEC 60134) will cause permanent damage to the device. Limiting values are stress ratings only and (proper) operation of the device at these or any other conditions above those given in the Recommended operating conditions section (if present) or the Characteristics sections of this document is not warranted. Constant or repeated exposure to limiting values will permanently and irreversibly affect the quality and reliability of the device.

Terms and conditions of commercial sale — NXP Semiconductors products are sold subject to the general terms and conditions of commercial sale, as published at <http://www.nxp.com/profile/terms>, unless otherwise agreed in a valid written individual agreement. In case an individual agreement is concluded only the terms and conditions of the respective agreement shall apply. NXP Semiconductors hereby expressly objects to applying the customer's general terms and conditions with regard to the purchase of NXP Semiconductors products by customer.

No offer to sell or license — Nothing in this document may be interpreted or construed as an offer to sell products that is open for acceptance or the grant, conveyance or implication of any license under any copyrights, patents or other industrial or intellectual property rights.

Export control — This document as well as the item(s) described herein may be subject to export control regulations. Export might require a prior authorization from competent authorities.

Non-automotive qualified products — Unless this data sheet expressly states that this specific NXP Semiconductors product is automotive qualified, the product is not suitable for automotive use. It is neither qualified nor tested in accordance with automotive testing or application requirements. NXP Semiconductors accepts no liability for inclusion and/or use of non-automotive qualified products in automotive equipment or applications.

In the event that customer uses the product for design-in and use in automotive applications to automotive specifications and standards, customer (a) shall use the product without NXP Semiconductors' warranty of the product for such automotive applications, use and specifications, and (b) whenever customer uses the product for automotive applications beyond NXP Semiconductors' specifications such use shall be solely at customer's own risk, and (c) customer fully indemnifies NXP Semiconductors for any

liability, damages or failed product claims resulting from customer design and use of the product for automotive applications beyond NXP Semiconductors' standard warranty and NXP Semiconductors' product specifications.

Quick reference data — The Quick reference data is an extract of the product data given in the Limiting values and Characteristics sections of this document, and as such is not complete, exhaustive or legally binding.

Translations — A non-English (translated) version of a document is for reference only. The English version shall prevail in case of any discrepancy between the translated and English versions.

12.4 Trademarks

Notice: All referenced brands, product names, service names and trademarks are the property of their respective owners.

13. Contact information

For more information, please visit: <http://www.nxp.com>

For sales office addresses, please send an email to: salesaddresses@nxp.com

14. Contents

1 Product profile 1

1.1 General description 1

1.2 Features and benefits 1

1.3 Applications 1

1.4 Quick reference data 2

2 Pinning information 2

2.1 Pinning 2

2.2 Pin description 2

3 Ordering information 3

4 Limiting values 3

5 Recommended operating conditions 3

6 Thermal characteristics 3

7 Characteristics 4

7.1 Graphs 5

8 Application information 8

9 Package outline 10

10 Abbreviations 11

11 Revision history 11

12 Legal information 12

12.1 Data sheet status 12

12.2 Definitions 12

12.3 Disclaimers 12

12.4 Trademarks 13

13 Contact information 13

14 Contents 14

Please be aware that important notices concerning this document and the product(s) described herein, have been included in section 'Legal information'.

© NXP B.V. 2013.

All rights reserved.

For more information, please visit: <http://www.nxp.com>
 For sales office addresses, please send an email to: salesaddresses@nxp.com

Date of release: 30 December 2013

Document identifier: BGU8053